

## Transient Voltage Suppressor

### Features

- 48 Watts Peak Power per Line ( $t_p = 8/20\mu s$ )
- Protects two I/O lines
- Low operating voltage: 5V
- Low capacitance(<1.0pF)
- Solid-state technology

### IEC COMPATIBILITY (EN61000-4)

- IEC 61000-4-2 (ESD)  $\pm 30kV$  (air),  $\pm 30kV$  (contact)
- IEC 61000-4-4 (EFT) 40A (5/50ns)
- IEC 61000-4-5 (Lightning) 4A (8/20 $\mu s$ )

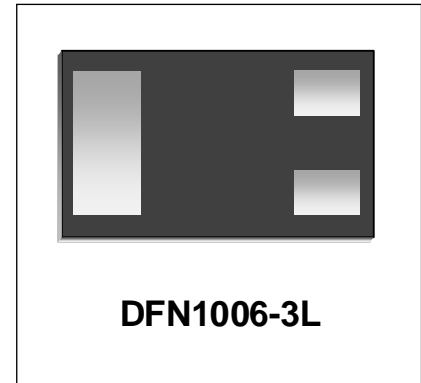

### Mechanical Characteristics

- JEDEC DFN1006-3L package
- Marking : Making Code
- Packaging : Tape and Reel per EIA 481
- RoHS Compliant & HF
- Device meets MSL1 requirement

### Applications

- FireWire & USB
- Sensitive Analog Inputs
- Portable Electronics
- LAN/WAN equipment
- Video Line Protection
- Microcontroller Input Protection

### Circuit Diagram

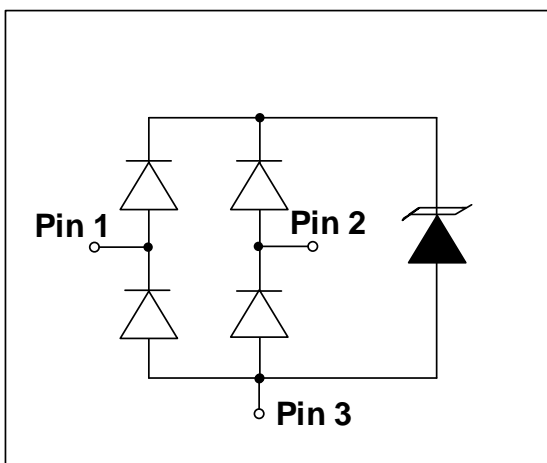

### Schematic & PIN Configuration

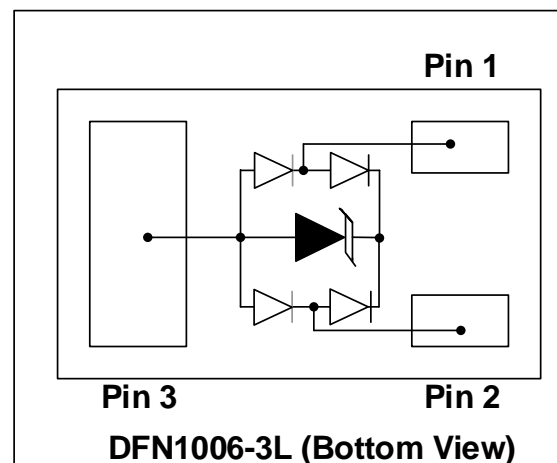

Absolute Maximum Rating			
Rating	Symbol	Value	Units
Peak Pulse Power ( $t_p=8/20\mu s$ )	$P_{PP}$	48	Watts
Peak Pulse Current ( $t_p=8/20\mu s$ )	$I_{PP}$	4	A
Operating Temperature	$T_J$	-55 to +125	$^{\circ}C$
Storage Temperature	$T_{STG}$	-55 to +150	$^{\circ}C$

Electrical Parameters

Symbol	Parameter
$I_{PP}$	Reverse Peak Pulse Current
$V_C$	Clamping Voltage @ $I_{PP}$
$V_{RWM}$	Reverse Stand-Off Voltage
$I_R$	Reverse Leakage Current @ $V_{RWM}$
$V_{BR}$	Breakdown Voltage @ $I_T$
$I_T$	Test Current
$I_F$	Forward Current
$V_F$	Forward Voltage @ $I_F$

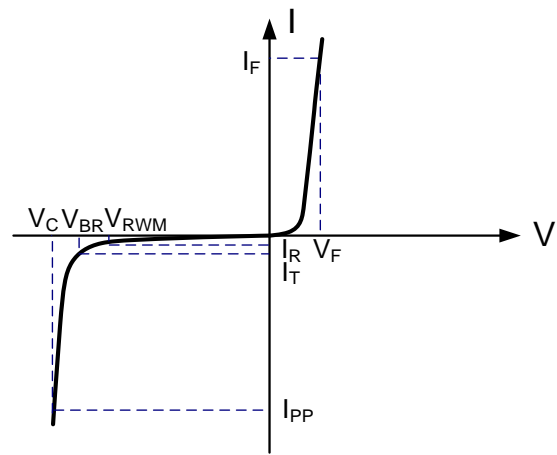

Electrical Characteristics (T=25 $^{\circ}C$  unless otherwise noted)

WE05MUC						
Parameter	Symbol	Conditions	Minimum	Typical	Maximum	Units
Reverse Stand-Off Voltage	$V_{RWM}$				5.0	V
Breakdown Voltage	$V_{BR}$	$I_T=1mA$	6.0		9.0	V
Forward Voltage	$V_F$	$I_F=10mA$	0.6		1.0	V
Reverse Leakage Current	$I_R$	$V_{RWM}=5V$			500	nA
Clamping Voltage	$V_C$	$I_{PP}=4A, t_p=8/20\mu s$		10.5	12	V
Dynamic Resistance <sup>1,2</sup>	$R_{DYN}$	TLP=0.2/100ns		0.56		$\Omega$
ESD Clamping Voltage <sup>1</sup>	$V_C$	$I_{PP} = 4A, t_p = 0.2/100ns$ (TLP)		10.5		V
ESD Clamping Voltage <sup>1</sup>	$V_C$	$I_{PP} = 16A, t_p = 0.2/100ns$ (TLP)		17.0		V
Junction Capacitance	$C_j$	$V_R=0V, f=1MHz$ Between I/O pins and Ground		0.5	1.0	pF
		$V_R=0V, f=1MHz$ Between I/O pins		0.2	0.5	pF

Notes : 1、TLP Setting :  $t_p=100ns, t_r=0.2ns, I_{TLP}$  and  $V_{TLP}$  sample window: $t_1=70ns$  to  $t_2=90ns$ .  
 2、Dynamic resistance calculated from  $I_{PP}=4A$  to  $I_{PP}=16A$  using "Best Fit".

Typical Characteristics

Figure 1: Peak Pulse Power Vs Pulse Time

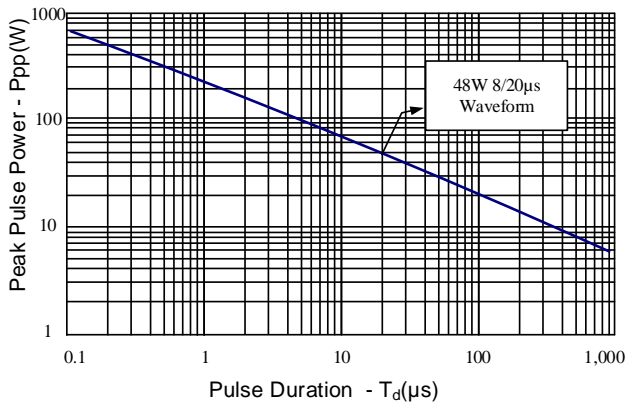

Figure 2: Power Derating Curve

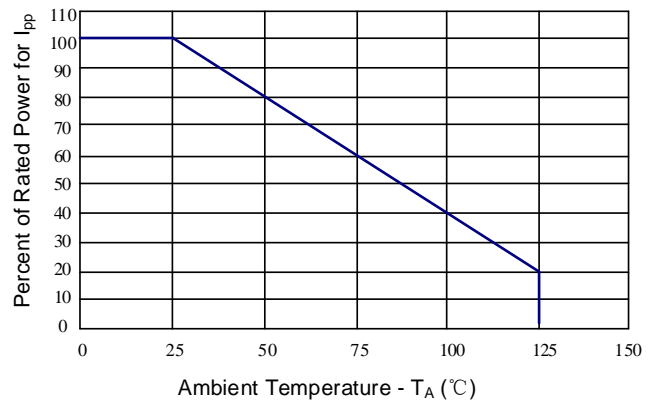

Figure 3: Clamping Voltage vs. Peak Pulse Current

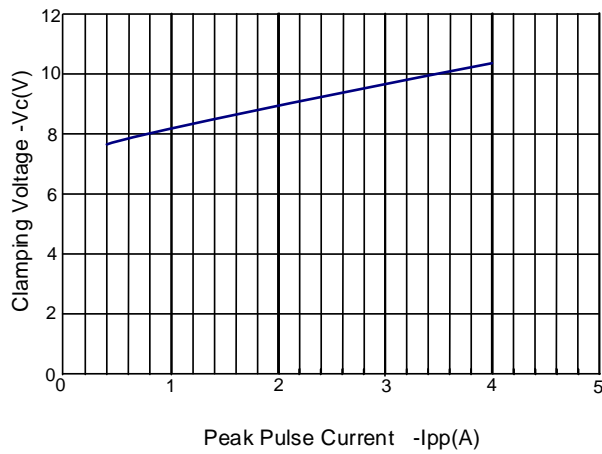

Figure 4: Capacitance vs. Reverse Voltage

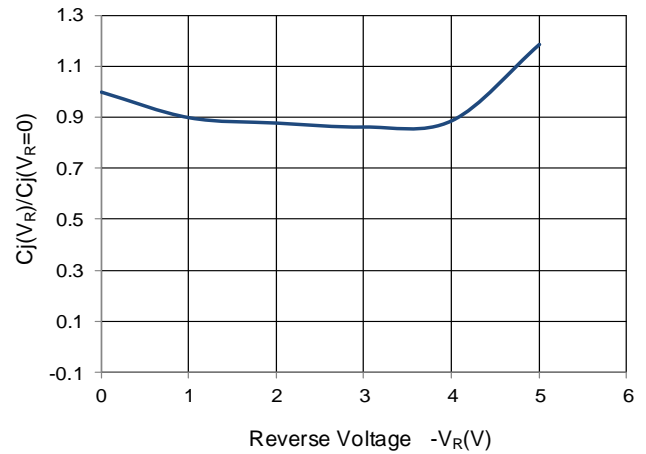

Figure 5: 8/20μs Pulse Waveform

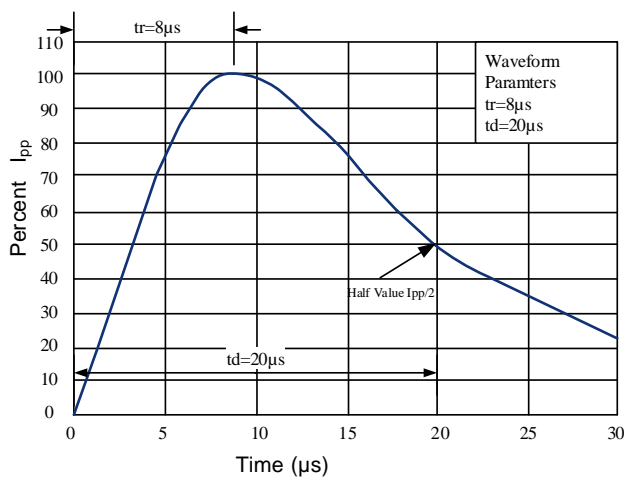
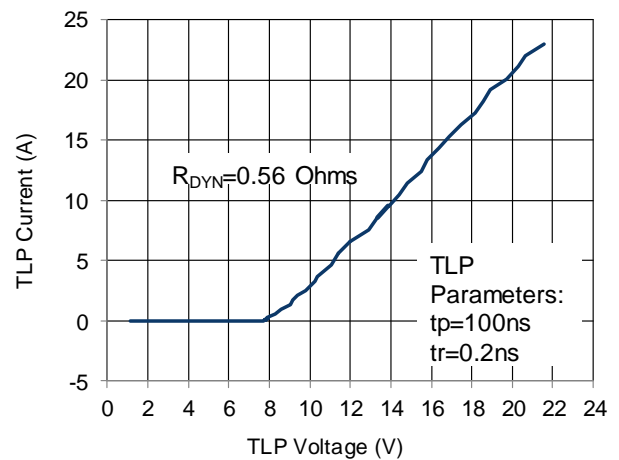
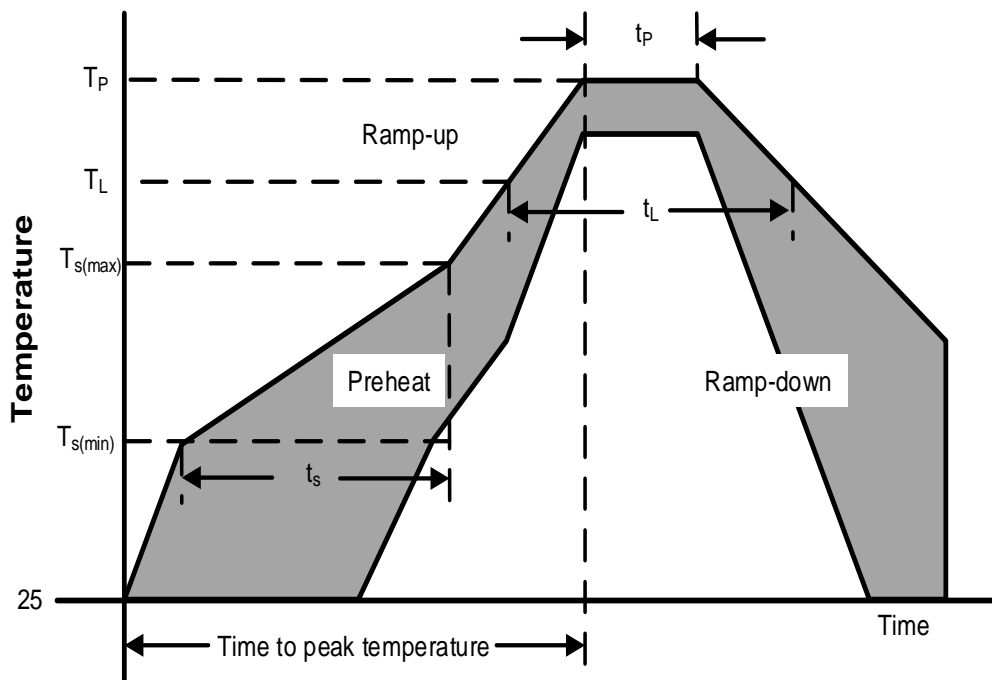

Figure 6: TLP I-V Curve



Soldering Parameters

Reflow Condition		Pb – Free assembly
Pre Heat	Temperature Min ( $T_{s(min)}$ )	150°C
	Temperature Max ( $T_{s(max)}$ )	200°C
	Time (min to max) ( $t_s$ )	60 – 190 secs
Average ramp up rate (Liquidus Temp) ( $T_L$ ) to peak		5°C/second max
$T_{s(max)}$ to $T_L$ — Ramp-up Rate		5°C/second max
Reflow	Temperature ( $T_L$ ) (Liquidus)	217°C
	Temperature ( $t_L$ )	60 – 150 seconds
Peak Temperature ( $T_P$ )		260+0/-5 °C
Time within actual peak Temperature ( $t_p$ )		20 – 40 seconds
Ramp-down Rate		5°C/second max
Time 25°C to peak Temperature ( $T_P$ )		8 minutes Max.
Do not exceed		280°C



**Tape And Reel Information**

**Reel Dimensions**

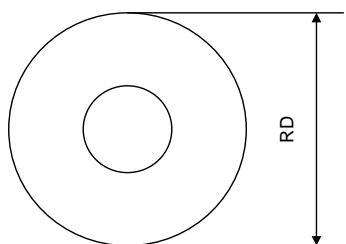

**Tape Dimensions**

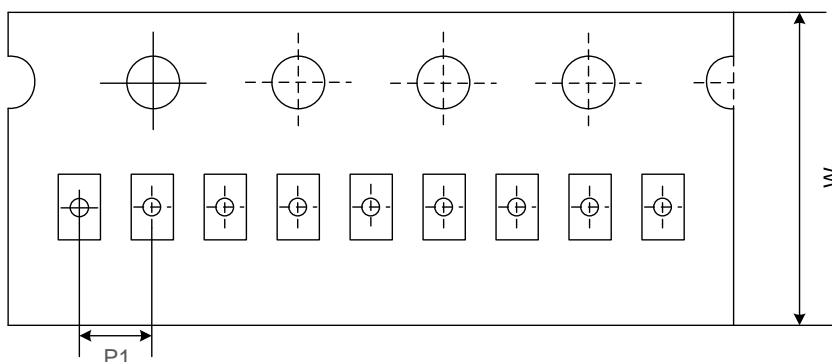

**Quadrant Assignments For PIN1 Orientation In Tape**

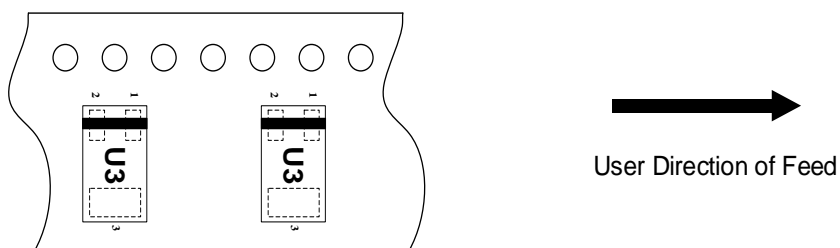

RD	Reel Dimensions	7 inch
W	Overall width of the carrier tape	8 mm
P1	Pitch between successive cavity centers	2mm

Outline Drawing – DFN1006-3L

**PACKAGE OUTLINE**

**DFN1006-3L**

SYMBOL	MILLIMETERS		
	MIN	NOM	MAX
A	0.45	0.50	0.60
A1	0	0.02	0.05
b	0.45	0.50	0.55
b1	0.10	0.15	0.20
C	0.12	0.15	0.18
D	0.95	1.00	1.05
e	0.65BSC		
E	0.55	0.60	0.65
E1	0.15	0.20	0.25
L	0.20	0.25	0.30
L1	0.05REF		

**Land Pattern**

**Marking Codes**

Part Number	Marking Code
WE05MUC	

**Package Information**

Qty: 10k/Reel

**CONTACT INFORMATION**

No.1001, Shiwan (7) Road, Pudong District, Shanghai, P.R.China.201207

Tel: 86-21-68969993 Fax: 86-21-50757680 Email: [market@way-on.com](mailto:market@way-on.com)

WAYON website: <http://www.way-on.com>

For additional information, please contact your local Sales Representative.

**WAYON** ® is registered trademark of Wayon Corporation.

Specifications are subject to change without notice.  
The device characteristics and parameters in this data sheet can and do vary in different applications and actual device performance may vary over time.  
Users should verify actual device performance in their specific applications.